

# Artemus Learns Math / Pre-K Funsheets

Name \_\_\_\_\_

Adding numbers.

+

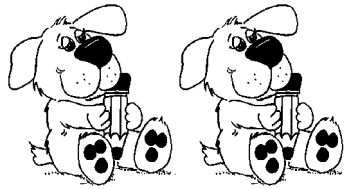

+



=

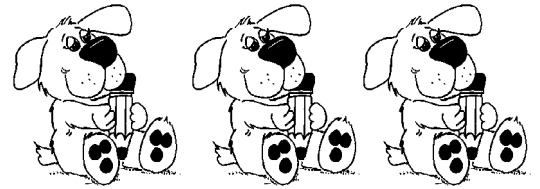

2

+

1

=

3

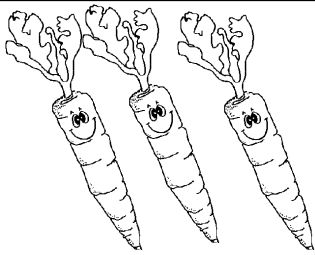

+

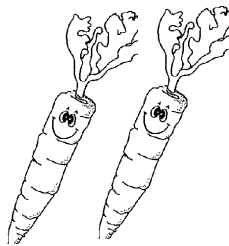

=

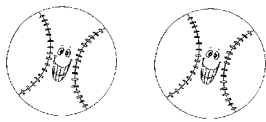
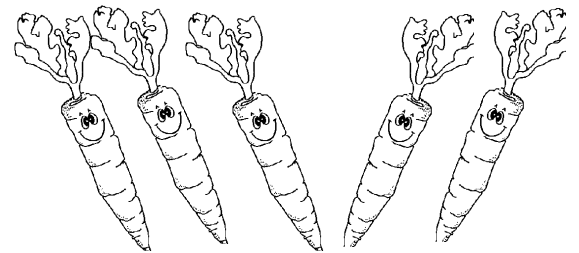

+

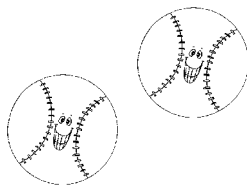

=

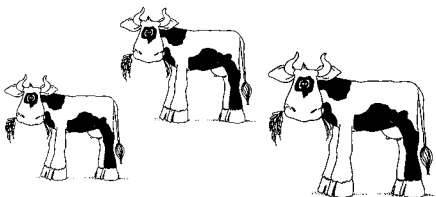
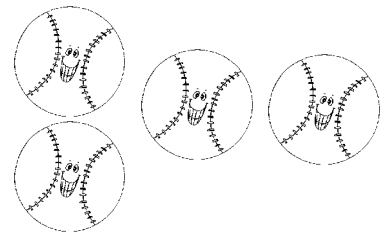

+

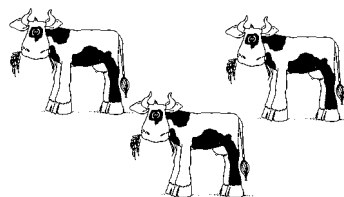

=

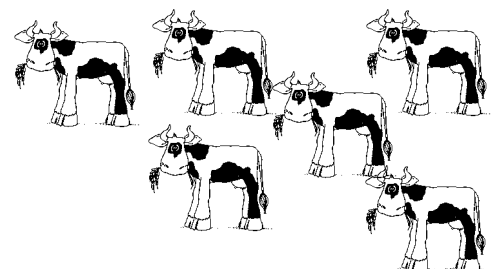

Adding numbers. +

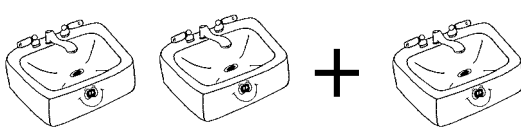
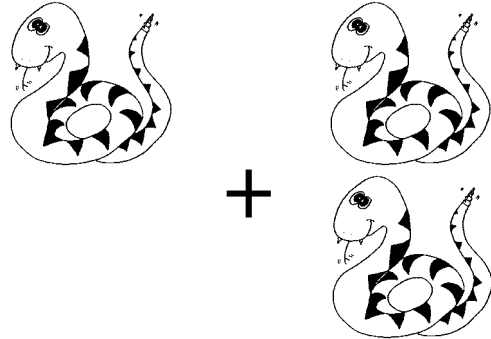
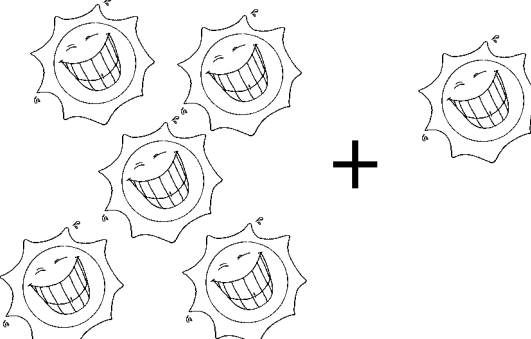
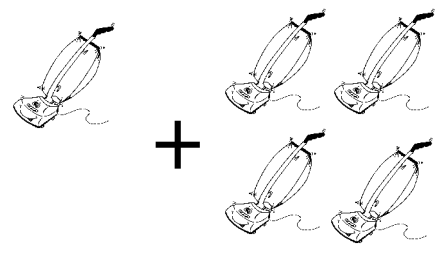
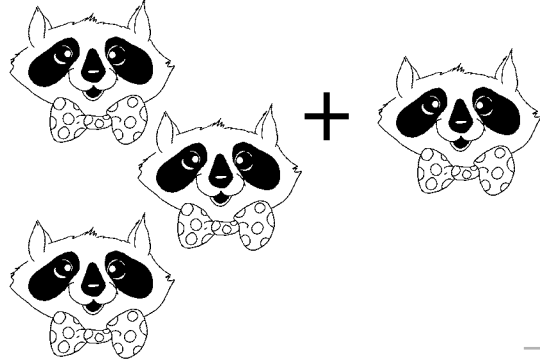
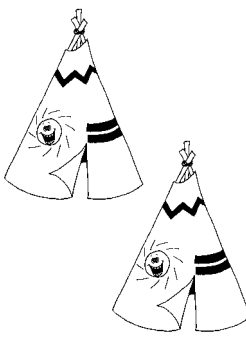
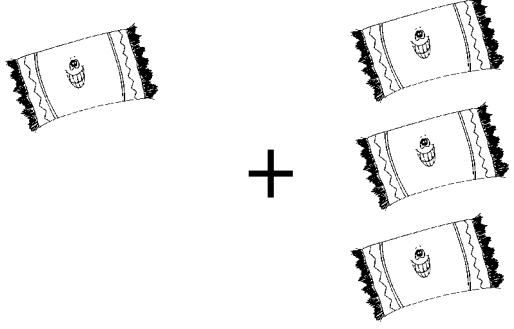
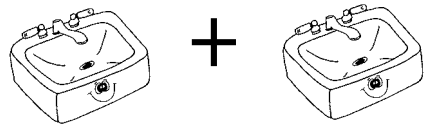
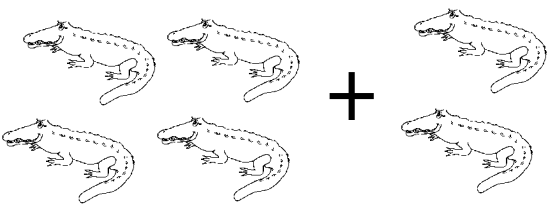
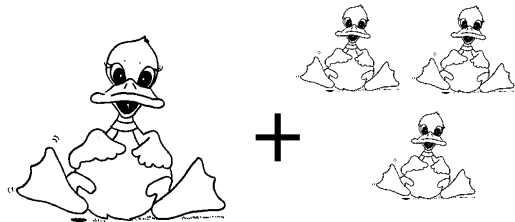

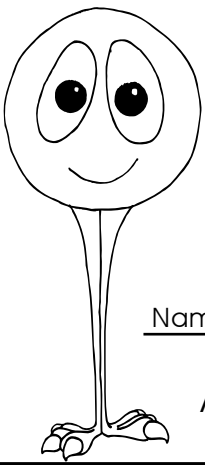
$$\begin{array}{r} 2 \\ + 1 \\ \hline \end{array}$$

$$\begin{array}{r} 1 \\ + 2 \\ \hline \end{array}$$

$$\begin{array}{r} 5 \\ + 1 \\ \hline \end{array}$$

$$\begin{array}{r} 1 \\ + 4 \\ \hline \end{array}$$

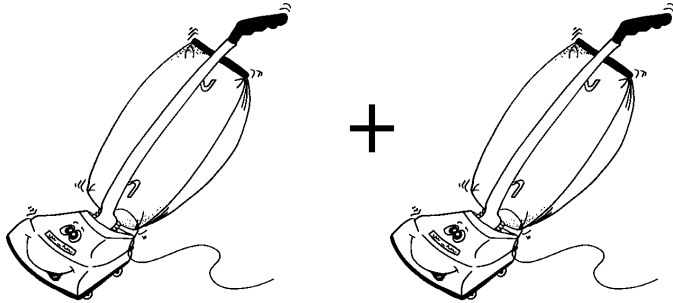
$$\begin{array}{r} 3 \\ + 1 \\ \hline \end{array}$$

$$\begin{array}{r} 2 \\ + 0 \\ \hline \end{array}$$

$$\begin{array}{r} 1 \\ + 3 \\ \hline \end{array}$$

$$\begin{array}{r} 1 \\ + 1 \\ \hline \end{array}$$

$$\begin{array}{r} 4 \\ + 2 \\ \hline \end{array}$$

$$\begin{array}{r} 1 \\ + 3 \\ \hline \end{array}$$



# Artemus Learns Math / Pre-K Funsheets

Name \_\_\_\_\_

Adding numbers. +



$$\begin{array}{r} 1 \\ + 1 \\ \hline 2 \end{array}$$

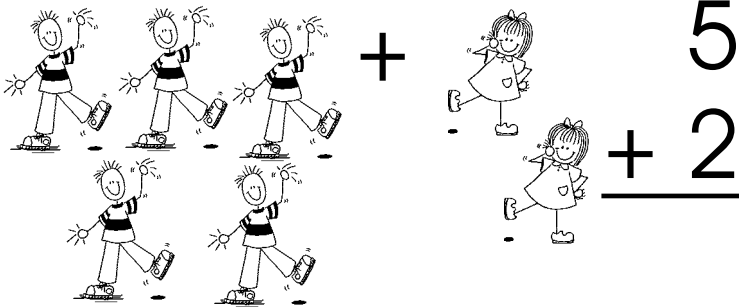

$$\begin{array}{r} 5 \\ + 2 \\ \hline \end{array}$$

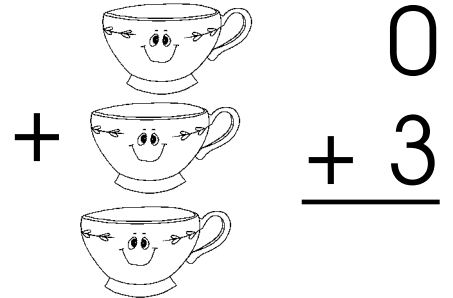

$$\begin{array}{r} 0 \\ + 3 \\ \hline \end{array}$$

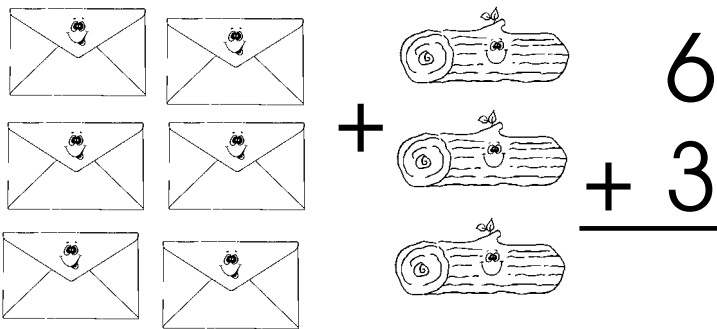

$$\begin{array}{r} 6 \\ + 3 \\ \hline \end{array}$$

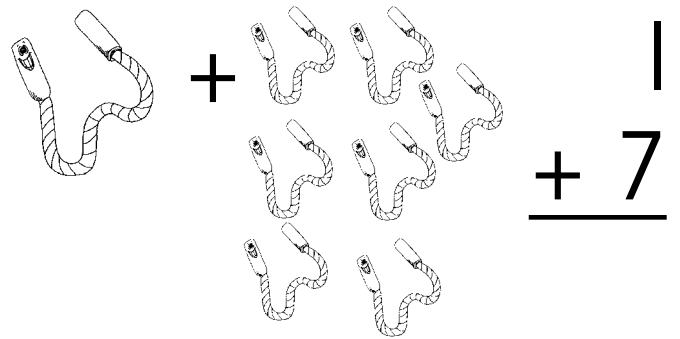

$$\begin{array}{r} 1 \\ + 7 \\ \hline \end{array}$$

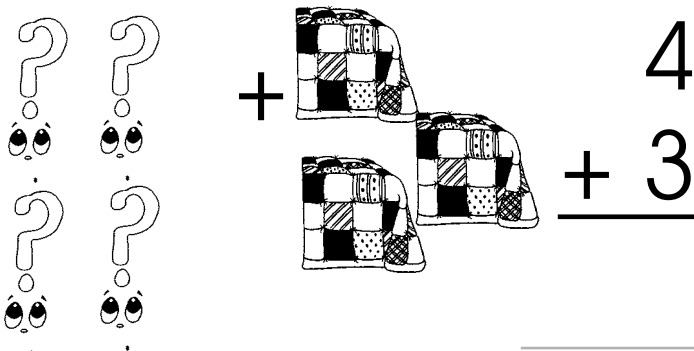

$$\begin{array}{r} 4 \\ + 3 \\ \hline \end{array}$$

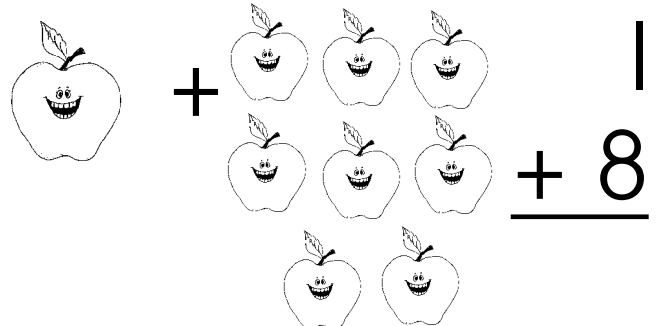

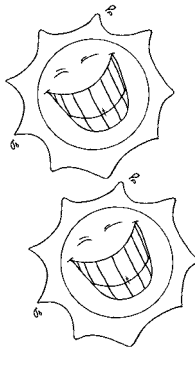
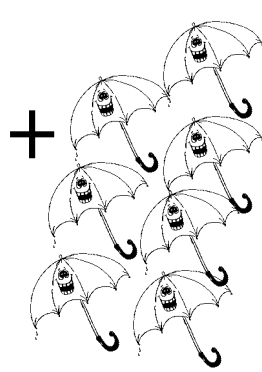

$$\begin{array}{r} 1 \\ + 8 \\ \hline \end{array}$$

Adding numbers. +

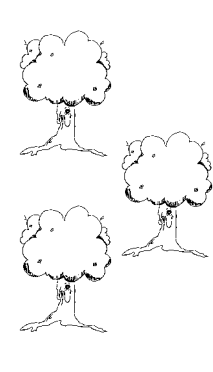
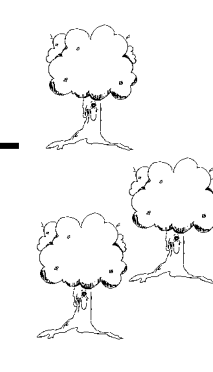
 +        $\begin{array}{r} 2 \\ + 7 \\ \hline \end{array}$

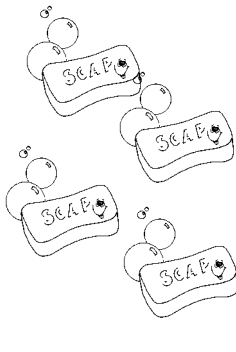
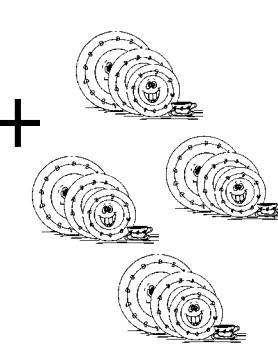
 +        $\begin{array}{r} 3 \\ + 3 \\ \hline \end{array}$

 +        $\begin{array}{r} 4 \\ + 4 \\ \hline \end{array}$

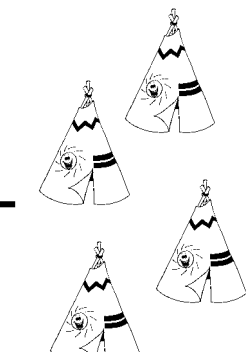
 +        $\begin{array}{r} 3 \\ + 4 \\ \hline \end{array}$

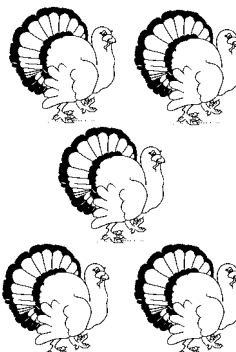
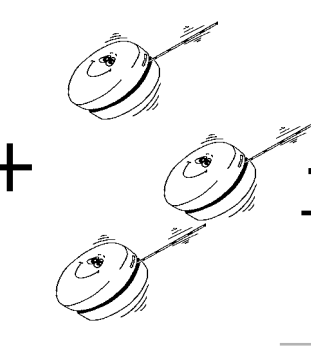
 +        $\begin{array}{r} 5 \\ + 3 \\ \hline \end{array}$

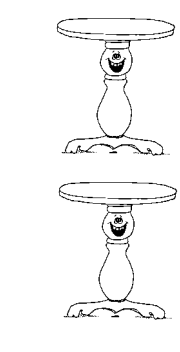
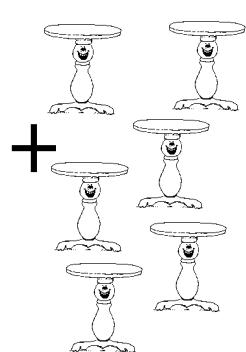
 +        $\begin{array}{r} 2 \\ + 6 \\ \hline \end{array}$

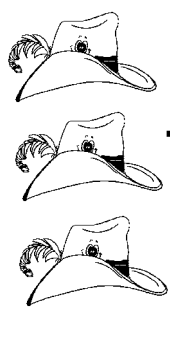
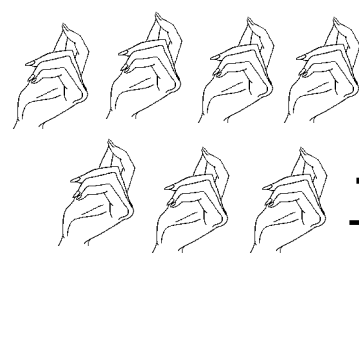
 +        $\begin{array}{r} 3 \\ + 7 \\ \hline \end{array}$

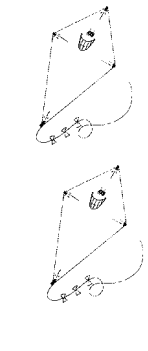
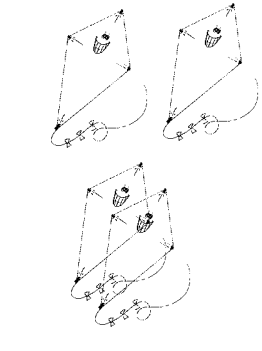
 +        $\begin{array}{r} 2 \\ + 4 \\ \hline \end{array}$

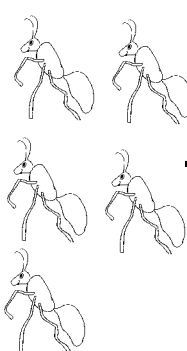
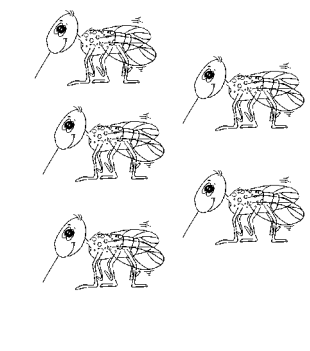
 +        $\begin{array}{r} 5 \\ + 5 \\ \hline \end{array}$

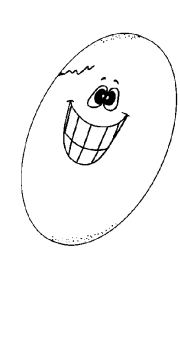
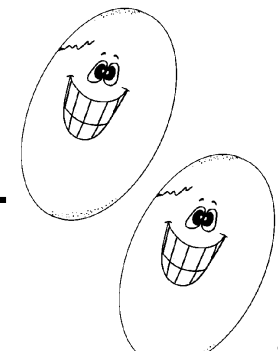
 +        $\begin{array}{r} 1 \\ + 2 \\ \hline \end{array}$

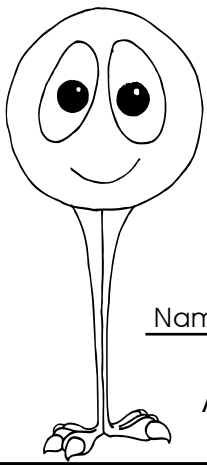

# Artemus Learns Math / Pre-K Funsheets

Name \_\_\_\_\_

Adding numbers. +

2 + 3 = 5

5 + 3 = 8

4 + 3 = 7

6 + 2 = 8

1 + 7 = 8

2 + 2 = 4

6 + 2 = 8

Adding numbers. +

6  
+ 2  
\_\_\_\_\_

3  
+ 5  
\_\_\_\_\_

4  
+ 6  
\_\_\_\_\_

7  
+ 2  
\_\_\_\_\_

3  
+ 4  
\_\_\_\_\_

4  
+ 4  
\_\_\_\_\_

=  $\begin{array}{r} 1 \\ + 1 \\ \hline \end{array}$   $\begin{array}{r} 1 \\ + 3 \\ \hline \end{array}$   
\_\_\_\_\_

=  $\begin{array}{r} 2 \\ + 1 \\ \hline \end{array}$   $\begin{array}{r} 1 \\ + 0 \\ \hline \end{array}$   
\_\_\_\_\_

=  $\begin{array}{r} 2 \\ + 2 \\ \hline \end{array}$   $\begin{array}{r} 4 \\ + 1 \\ \hline \end{array}$   
\_\_\_\_\_

=  $\begin{array}{r} 0 \\ + 2 \\ \hline \end{array}$   $\begin{array}{r} 3 \\ + 2 \\ \hline \end{array}$   
\_\_\_\_\_

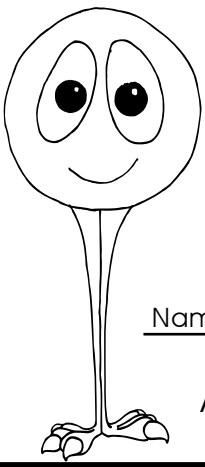

# Artemus Learns Math / Pre-K Funsheets

Name \_\_\_\_\_

Adding numbers. +

$$\begin{array}{r} 1 \\ + 1 \\ \hline 2 \end{array}$$

$$\begin{array}{r} 1 \\ + 2 \\ \hline 3 \end{array}$$

$$\begin{array}{r} 2 \\ + 1 \\ \hline 3 \end{array}$$

$$\begin{array}{r} 0 \\ + 1 \\ \hline 1 \end{array}$$

$$\begin{array}{r} 4 \\ + 1 \\ \hline \end{array}$$

$$\begin{array}{r} 1 \\ + 5 \\ \hline \end{array}$$

$$\begin{array}{r} 2 \\ + 2 \\ \hline \end{array}$$

$$\begin{array}{r} 2 \\ + 0 \\ \hline \end{array}$$

$$\begin{array}{r} 2 \\ + 4 \\ \hline \end{array}$$

$$\begin{array}{r} 3 \\ + 1 \\ \hline \end{array}$$

$$\begin{array}{r} 2 \\ + 5 \\ \hline \end{array}$$

$$\begin{array}{r} 1 \\ + 3 \\ \hline \end{array}$$

$$\begin{array}{r} 3 \\ + 0 \\ \hline \end{array}$$

$$\begin{array}{r} 0 \\ + 5 \\ \hline \end{array}$$

$$\begin{array}{r} 3 \\ + 2 \\ \hline \end{array}$$

$$\begin{array}{r} 6 \\ + 1 \\ \hline \end{array}$$

Adding numbers. +

$$\begin{array}{r} 2 \\ + 2 \\ \hline \end{array}$$

$$\begin{array}{r} 2 \\ + 3 \\ \hline \end{array}$$

$$\begin{array}{r} 2 \\ + 4 \\ \hline \end{array}$$

$$\begin{array}{r} 3 \\ + 3 \\ \hline \end{array}$$

$$\begin{array}{r} 3 \\ + 2 \\ \hline \end{array}$$

$$\begin{array}{r} 3 \\ + 1 \\ \hline \end{array}$$

$$\begin{array}{r} 2 \\ + 4 \\ \hline \end{array}$$

$$\begin{array}{r} 3 \\ + 4 \\ \hline \end{array}$$

$$\begin{array}{r} 4 \\ + 4 \\ \hline \end{array}$$

$$\begin{array}{r} 5 \\ + 1 \\ \hline \end{array}$$

$$\begin{array}{r} 2 \\ + 6 \\ \hline \end{array}$$

$$\begin{array}{r} 7 \\ + 1 \\ \hline \end{array}$$

$$\begin{array}{r} 5 \\ + 1 \\ \hline \end{array}$$

$$\begin{array}{r} 2 \\ + 7 \\ \hline \end{array}$$

$$\begin{array}{r} 1 \\ + 2 \\ \hline \end{array}$$

$$\begin{array}{r} 1 \\ + 9 \\ \hline \end{array}$$

$$\begin{array}{r} 2 \\ + 8 \\ \hline \end{array}$$

$$\begin{array}{r} 7 \\ + 3 \\ \hline \end{array}$$

$$\begin{array}{r} 4 \\ + 2 \\ \hline \end{array}$$

$$\begin{array}{r} 8 \\ + 1 \\ \hline \end{array}$$

$$\begin{array}{r} 7 \\ + 1 \\ \hline \end{array}$$

$$\begin{array}{r} 1 \\ + 7 \\ \hline \end{array}$$

$$\begin{array}{r} 3 \\ + 3 \\ \hline \end{array}$$

$$\begin{array}{r} 5 \\ + 5 \\ \hline \end{array}$$

$$\begin{array}{r} 8 \\ + 2 \\ \hline \end{array}$$

$$\begin{array}{r} 7 \\ + 2 \\ \hline \end{array}$$

$$\begin{array}{r} 9 \\ + 1 \\ \hline \end{array}$$

$$\begin{array}{r} 4 \\ + 5 \\ \hline \end{array}$$

$$\begin{array}{r} 1 \\ + 8 \\ \hline \end{array}$$

$$\begin{array}{r} 5 \\ + 4 \\ \hline \end{array}$$



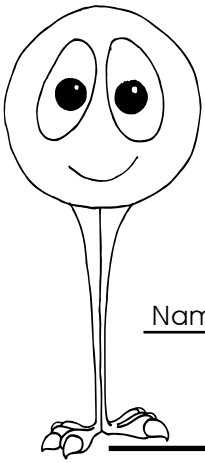

# Artemus Learns Math / Pre-K Funsheets

Name \_\_\_\_\_

Taking away numbers. —

$2 - 1 = 1$

$3 - 2 = \underline{\quad}$

$4 - 3 = \underline{\quad}$

$2 - 2 = \underline{\quad}$

Taking away numbers. —

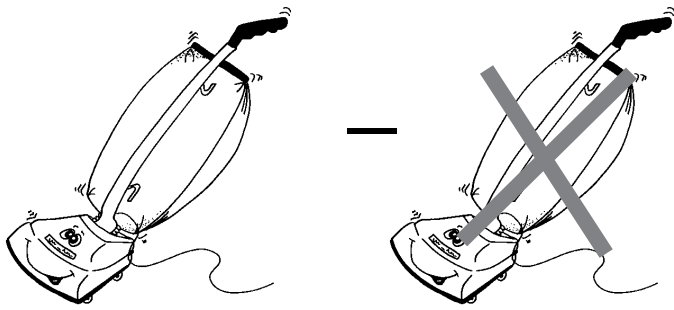

$$\begin{array}{r} 1 \\ - 1 \\ \hline 0 \end{array}$$

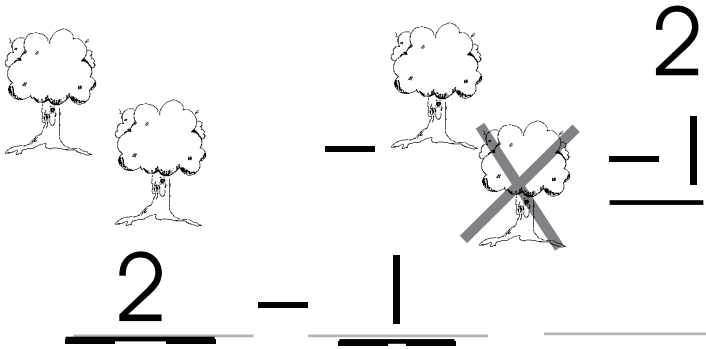

2

$$\begin{array}{r} 2 \\ - 1 \\ \hline \end{array}$$

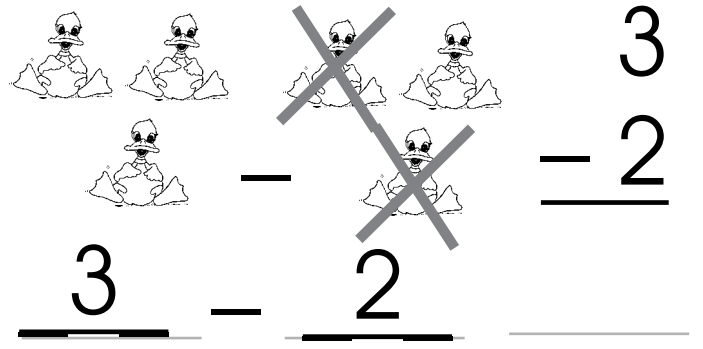

3

$$\begin{array}{r} 3 \\ - 2 \\ \hline \end{array}$$

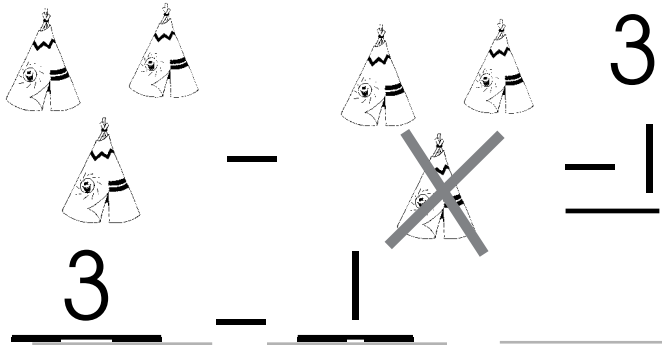

3

$$\begin{array}{r} 3 \\ - 1 \\ \hline \end{array}$$

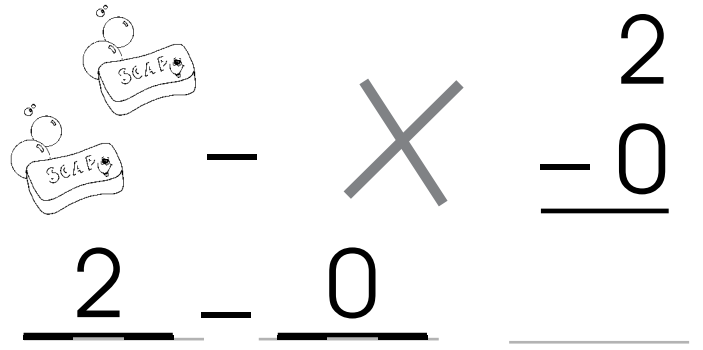

2

$$\begin{array}{r} 2 \\ - 0 \\ \hline \end{array}$$

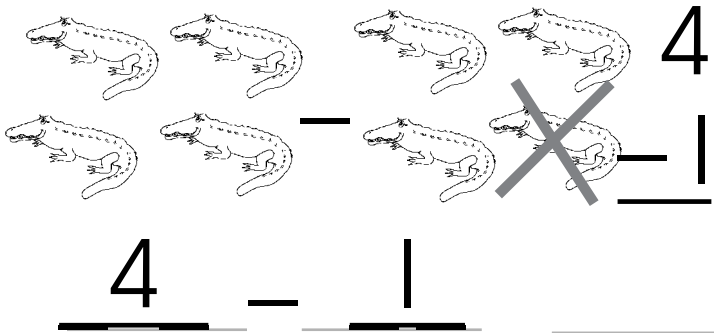

4

$$\begin{array}{r} 4 \\ - 1 \\ \hline \end{array}$$

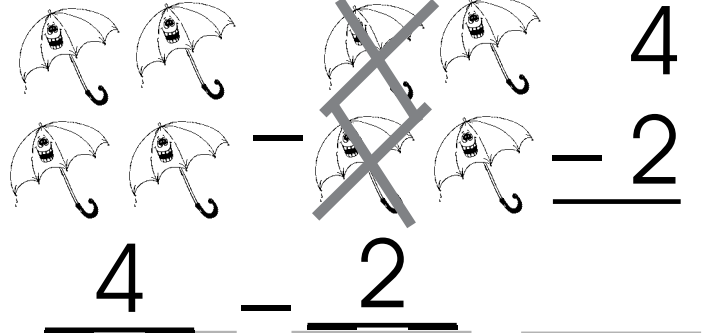

4

$$\begin{array}{r} 4 \\ - 2 \\ \hline \end{array}$$

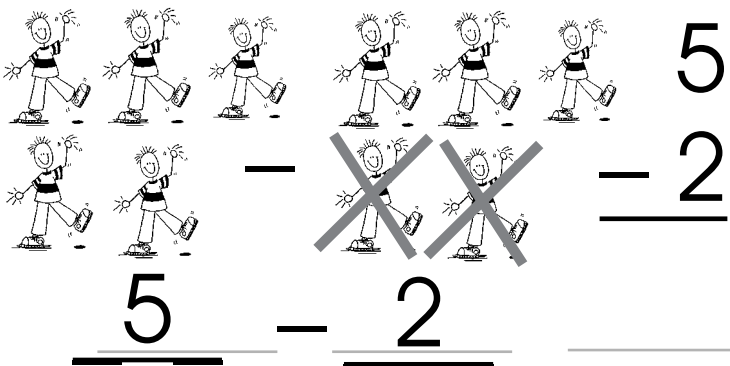

5

$$\begin{array}{r} 5 \\ - 2 \\ \hline \end{array}$$

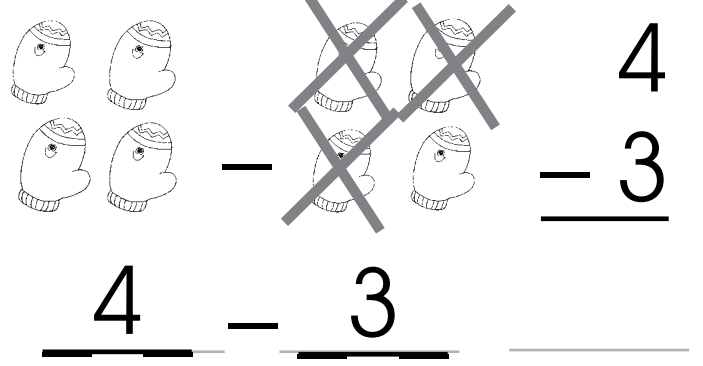

4

$$\begin{array}{r} 4 \\ - 3 \\ \hline \end{array}$$

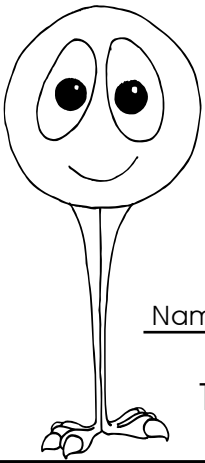

# Artemus Learns Math / Pre-K Funsheets

Name \_\_\_\_\_

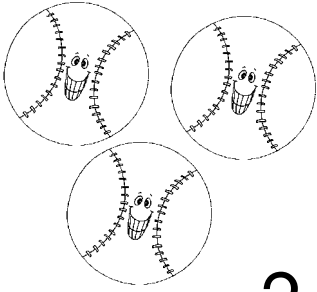
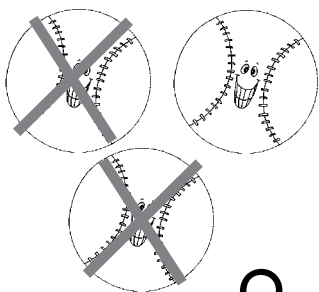

Taking away numbers. —

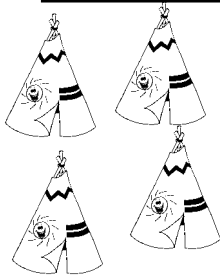
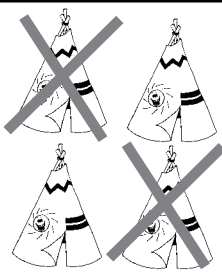
	—		
<u>3</u>		<u>2</u>	<u>1</u>

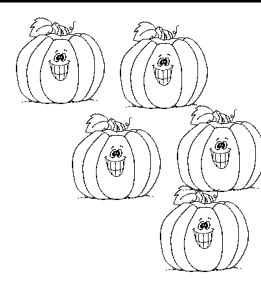
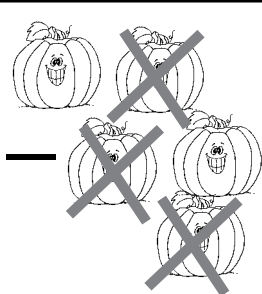
	—		<u>4</u>
			<u>2</u>

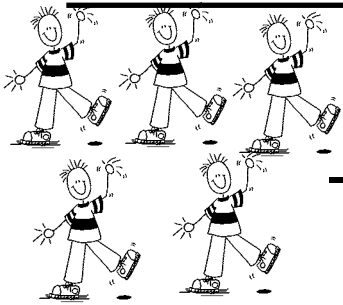
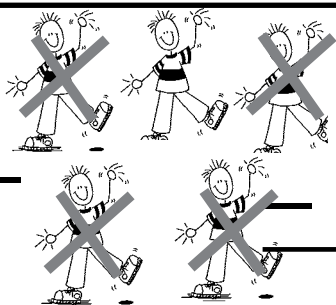
	—		<u>5</u>
			<u>3</u>

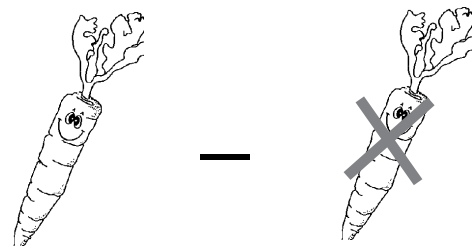
	—		<u>5</u>
			<u>4</u>

	—		<u>1</u>
			<u>1</u>

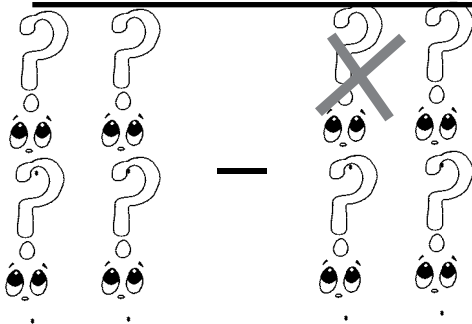
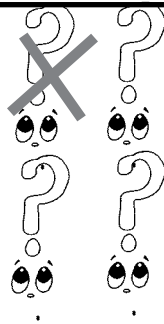
	—		<u>4</u>
			<u>1</u>

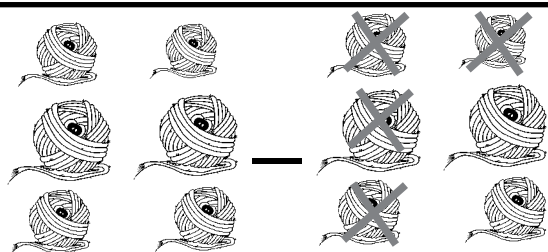
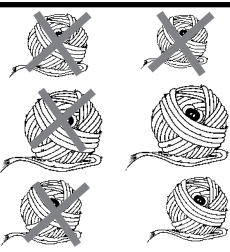
	—		<u>6</u>
			<u>4</u>

Taking away numbers. —

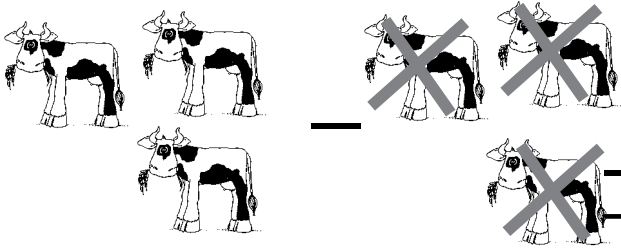

3  
—  
3

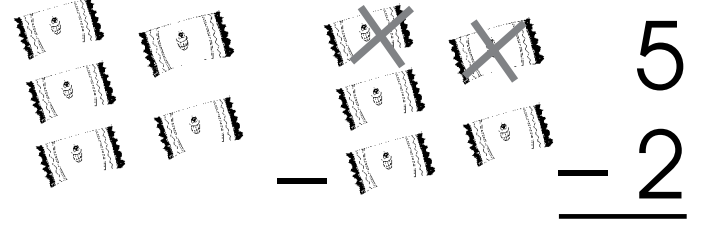

5  
—  
2

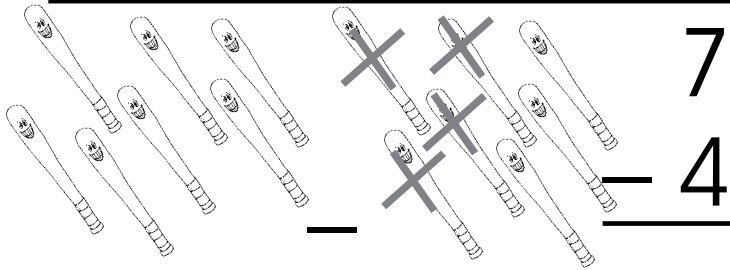

7  
—  
4

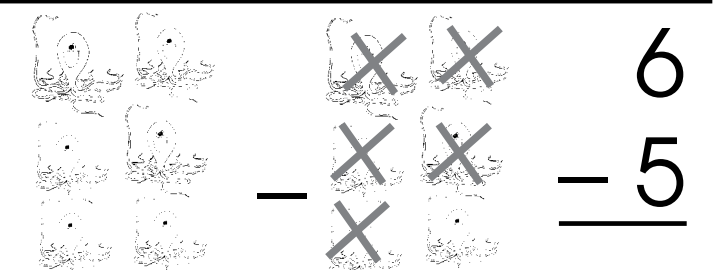

6  
—  
5

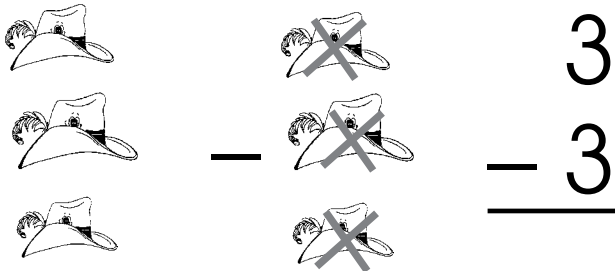

3  
—  
3

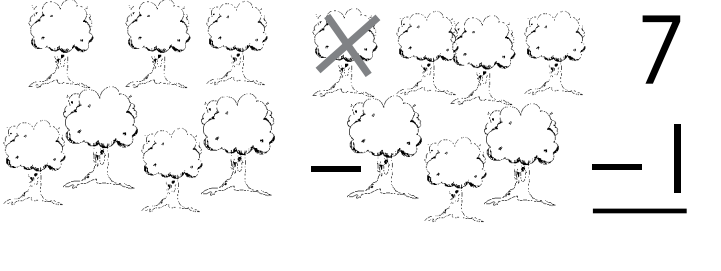

7  
—  
1

$$\begin{array}{r} 2 \\ -1 \\ \hline \end{array} \quad \begin{array}{r} 3 \\ -1 \\ \hline \end{array}$$

$$\begin{array}{r} 4 \\ -1 \\ \hline \end{array} \quad \begin{array}{r} 5 \\ -1 \\ \hline \end{array}$$

$$\begin{array}{r} 6 \\ -1 \\ \hline \end{array} \quad \begin{array}{r} 7 \\ -1 \\ \hline \end{array}$$

$$\begin{array}{r} 8 \\ -1 \\ \hline \end{array} \quad \begin{array}{r} 9 \\ -1 \\ \hline \end{array}$$

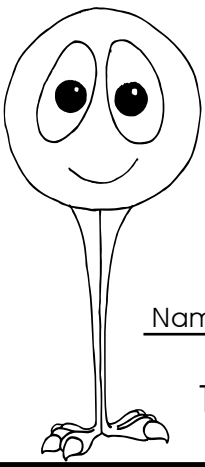

# Artemus Learns Math / Pre-K Funsheets

Name \_\_\_\_\_

Taking away numbers. —

$$\begin{array}{r} 2 \\ -1 \\ \hline \end{array}$$

$$\begin{array}{r} 3 \\ -2 \\ \hline \end{array}$$

$$\begin{array}{r} 4 \\ -3 \\ \hline \end{array}$$

$$\begin{array}{r} 5 \\ -4 \\ \hline \end{array}$$

$$\begin{array}{r} 6 \\ -2 \\ \hline \end{array}$$

$$\begin{array}{r} 6 \\ -3 \\ \hline \end{array}$$

$$\begin{array}{r} 7 \\ -2 \\ \hline \end{array}$$

$$\begin{array}{r} 7 \\ -3 \\ \hline \end{array}$$

$$\begin{array}{r} 4 \\ -4 \\ \hline \end{array}$$

$$\begin{array}{r} 10 \\ -10 \\ \hline \end{array}$$

$$\begin{array}{r} 8 \\ -2 \\ \hline \end{array}$$

$$\begin{array}{r} 8 \\ -1 \\ \hline \end{array}$$

$$\begin{array}{r} 9 \\ -2 \\ \hline \end{array}$$

$$\begin{array}{r} 5 \\ -3 \\ \hline \end{array}$$

$$\begin{array}{r} 3 \\ -1 \\ \hline \end{array}$$

$$\begin{array}{r} 2 \\ -2 \\ \hline \end{array}$$

Taking away numbers. —

$$\begin{array}{r} 4 \\ -1 \\ \hline \end{array} \quad \begin{array}{r} 4 \\ -2 \\ \hline \end{array}$$

\_\_\_\_\_

$$\begin{array}{r} 4 \\ -3 \\ \hline \end{array} \quad \begin{array}{r} 4 \\ -0 \\ \hline \end{array}$$

\_\_\_\_\_

$$\begin{array}{r} 5 \\ -2 \\ \hline \end{array} \quad \begin{array}{r} 5 \\ -3 \\ \hline \end{array}$$

\_\_\_\_\_

$$\begin{array}{r} 5 \\ -4 \\ \hline \end{array} \quad \begin{array}{r} 5 \\ -1 \\ \hline \end{array}$$

\_\_\_\_\_

$$\begin{array}{r} 6 \\ -5 \\ \hline \end{array} \quad \begin{array}{r} 6 \\ -4 \\ \hline \end{array}$$

\_\_\_\_\_

$$\begin{array}{r} 6 \\ -3 \\ \hline \end{array} \quad \begin{array}{r} 6 \\ -2 \\ \hline \end{array}$$

\_\_\_\_\_

$$\begin{array}{r} 7 \\ -6 \\ \hline \end{array} \quad \begin{array}{r} 7 \\ -4 \\ \hline \end{array}$$

\_\_\_\_\_

$$\begin{array}{r} 7 \\ -3 \\ \hline \end{array} \quad \begin{array}{r} 7 \\ -5 \\ \hline \end{array}$$

\_\_\_\_\_

$$\begin{array}{r} 8 \\ -8 \\ \hline \end{array} \quad \begin{array}{r} 8 \\ -3 \\ \hline \end{array}$$

\_\_\_\_\_

$$\begin{array}{r} 8 \\ -2 \\ \hline \end{array} \quad \begin{array}{r} 8 \\ -1 \\ \hline \end{array}$$

\_\_\_\_\_

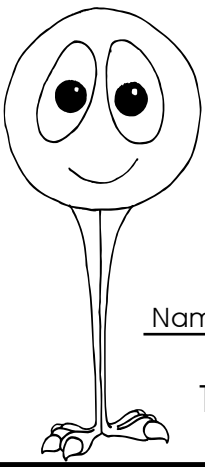

# Artemus Learns Math / Pre-K Funsheets

Name \_\_\_\_\_

Taking away numbers. —

$$\begin{array}{r} 6 \\ -7 \\ \hline 1 \end{array}$$

$$\begin{array}{r} 1 \\ -1 \\ \hline 0 \end{array}$$

$$\begin{array}{r} 6 \\ -2 \\ \hline 4 \end{array}$$

$$\begin{array}{r} 4 \\ -3 \\ \hline 1 \end{array}$$

$$\begin{array}{r} 10 \\ -9 \\ \hline \end{array}$$

$$\begin{array}{r} 10 \\ -2 \\ \hline \end{array}$$

$$\begin{array}{r} 10 \\ -1 \\ \hline \end{array}$$

$$\begin{array}{r} 10 \\ -0 \\ \hline \end{array}$$

$$\begin{array}{r} 5 \\ -4 \\ \hline \end{array}$$

$$\begin{array}{r} 7 \\ -6 \\ \hline \end{array}$$

$$\begin{array}{r} 6 \\ -3 \\ \hline \end{array}$$

$$\begin{array}{r} 8 \\ -4 \\ \hline \end{array}$$

$$\begin{array}{r} 5 \\ -1 \\ \hline \end{array}$$

$$\begin{array}{r} 4 \\ -0 \\ \hline \end{array}$$

$$\begin{array}{r} 0 \\ -0 \\ \hline \end{array}$$

$$\begin{array}{r} 8 \\ -0 \\ \hline \end{array}$$

Taking away numbers. —

$$\begin{array}{r} 3 \\ -1 \\ \hline \end{array}$$

$$\begin{array}{r} 3 \\ -2 \\ \hline \end{array}$$

$$\begin{array}{r} 3 \\ -3 \\ \hline \end{array}$$

$$\begin{array}{r} 4 \\ -1 \\ \hline \end{array}$$

$$\begin{array}{r} 4 \\ -3 \\ \hline \end{array}$$

$$\begin{array}{r} 4 \\ -2 \\ \hline \end{array}$$

$$\begin{array}{r} 5 \\ -2 \\ \hline \end{array}$$

$$\begin{array}{r} 5 \\ -3 \\ \hline \end{array}$$

$$\begin{array}{r} 5 \\ -4 \\ \hline \end{array}$$

$$\begin{array}{r} 6 \\ -4 \\ \hline \end{array}$$

$$\begin{array}{r} 6 \\ -5 \\ \hline \end{array}$$

$$\begin{array}{r} 6 \\ -2 \\ \hline \end{array}$$

$$\begin{array}{r} 7 \\ -5 \\ \hline \end{array}$$

$$\begin{array}{r} 7 \\ -4 \\ \hline \end{array}$$

$$\begin{array}{r} 7 \\ -3 \\ \hline \end{array}$$

$$\begin{array}{r} 8 \\ -5 \\ \hline \end{array}$$

$$\begin{array}{r} 8 \\ -6 \\ \hline \end{array}$$

$$\begin{array}{r} 8 \\ -7 \\ \hline \end{array}$$

$$\begin{array}{r} 9 \\ -8 \\ \hline \end{array}$$

$$\begin{array}{r} 9 \\ -6 \\ \hline \end{array}$$

$$\begin{array}{r} 9 \\ -5 \\ \hline \end{array}$$

$$\begin{array}{r} 10 \\ -9 \\ \hline \end{array}$$

$$\begin{array}{r} 10 \\ -8 \\ \hline \end{array}$$

$$\begin{array}{r} 10 \\ -0 \\ \hline \end{array}$$

$$\begin{array}{r} 2 \\ -1 \\ \hline \end{array}$$

$$\begin{array}{r} 2 \\ -0 \\ \hline \end{array}$$

$$\begin{array}{r} 2 \\ -2 \\ \hline \end{array}$$

$$\begin{array}{r} 1 \\ -1 \\ \hline \end{array}$$

$$\begin{array}{r} 9 \\ -1 \\ \hline \end{array}$$

$$\begin{array}{r} 10 \\ -1 \\ \hline \end{array}$$